



CSI-3K-S22002-E
CSI-5K-S22002-E



PV Inverter User Manual

(Part No: 6431000400 Released Date: June, 2020)

Contents

- 1 Introduction..... 1
 - 1.1 General Information 1
 - 1.2 User Manual Disclaimer 1
 - 1.3 Limitation of Liability..... 1
 - 1.4 Target Group 1
 - 1.5 Symbol Conventions..... 1
 - 1.5.1 Warnings in the manual 1
 - 1.5.2 Labels on product and packaging..... 2
- 2 Safety Instruction 3
 - 2.1 General Safety 3
 - 2.2 Notice for Use 3
 - 2.2.1 Personnel requirements..... 3
 - 2.2.2 Operation requirements 3
 - 2.2.3 Protecting labels 3
- 3 Product Overview 4
 - 3.1 Product Introduction 4
 - 3.2 Appearance 4
 - 3.3 Product Nameplate 5
- 4 Storage 7
- 5 Unpackaging and Inspection 7
- 6 Installation..... 8
 - 6.1 Basic Installation Requirements 8
 - 6.2 Mounting Wall-mounting Bracket 10
 - 6.3 Installing Inverter 11
- 7 Electrical Connection..... 12
 - 7.1 Safety 12
 - 7.2 Network Diagram 12
 - 7.3 Meter/CT Connection (Optional) 12
 - 7.3.1 Meter connection 12
 - 7.3.2 CT connection 13
 - 7.4 Cable Description 13
 - 7.5 Wiring PE Cable 13
 - 7.6 Wiring AC Output 14

7.7 Wiring DC Input	16
7.71 Requirement for DC input	17
7.72 Wiring	17
7.73 Connecting PV array (DC input).....	18
7.8 Wiring CT/Meter	19
8 Communication	20
8.1 Communication Mode	20
8.2 RS485	21
8.3 External GPRS (Optional).....	21
8.4 External WiFi	21
9 Commissioning Inverter	21
9.1 Checking Electrical	21
9.2 Checking Mechanical.....	22
9.3 Start-UP Inverter	22
9.4 LED Indicators.....	23
9.5 Switch off	23
10 Daily Maintenance.....	23
11 Trouble Shooting	24
11.1 Warning.....	24
11.2 Errors.....	24
12 Handling the Inverter	26
12.1 Removing Inverter	26
12.2 Packing Inverter.....	26
12.3 Disposing Inverter	27
ANNEX A: Acronyms and Abbreviations	28
ANNEX B: Specification.....	29

1 Introduction

1.1 General Information

This manual provides important safety information on relating to the installation, maintenance and usage of single phase PV inverters. Both users and professional installers must read these guidelines carefully and strictly follow these instructions. Failure to follow these instructions may result in death, serious injury or property damage.

Only qualified professionals and service personnel can do the installation and operation (refer to 62109-1). Installers must inform end-users (consumers) about the aforesaid information accordingly. This manual is only valid for the PV inverter types, CSI-5K-S22002-E and CSI-3K-S22002-E produced by Canadian Solar Inc.

1.2 User Manual Disclaimer

The information contained in this manual is subject to change by Canadian Solar Inc. without prior notice. Canadian Solar Inc. gives no warranty of any kind whatsoever, either explicitly or implicitly, with respect to the information contained herein.

In the event of any inconsistency among different language versions of this document, the English version shall prevail. Please refer to our product lists and documents published on our website at: <http://www.canadiansolar.com> as these lists are updated on a regular basis.

1.3 Limitation of Liability

Canadian Solar Inc. shall not be held responsible for damages of any kind, including-without limitation-bodily harm, injury or damage to property, in connection with handling PV inverters, system installation, or compliance or non-compliance with the instructions set forth in this manual.

1.4 Target Group

This document is intended for installers and users.





1.5 Symbol Conventions

The symbols that may be found in this document or on the product packaging are defined as follows.









1.5.1 Warnings in the manual

A warning describes a hazard to equipment or personnel. It calls attention to procedure or practice.

Symbol	Description
--------	-------------

 DANGER	<p>DANGER indicates an imminently hazardous situation which, if not avoided, will result in death or serious injury.</p>
 WARNING	<p>WARNING indicates a potentially hazardous situation which, if not avoided, could result in death or serious injury.</p>
 CAUTION	<p>CAUTION indicates a potentially hazardous situation which, if not avoided, could result in minor or moderate injury.</p>
 NOTICE	<p>NOTICE indicates a situation which, if not avoided, could result in equipment or property damage.</p>
 Information	<p>Information indicates that you must read carefully to ensure optimal operation of the system.</p>

1.5.2 Labels on product and packaging

Symbol	Description
	<p>Hot surfaces! Risk of burns due to hot components!</p>
	<p>Danger to life due to high voltage!</p>
	<p>Time need to discharge stored energy in the capacitors.</p>
	<p>Grounding</p>
	<p>Direct Current (D C)</p>
	<p>Alternating Current(A C)</p>
	<p>Check the user manual before service.</p>
	<p>CE mark.</p>
	<p>WEEE designation.</p>

2 Safety Instruction

2.1 General Safety

The Inverter has been designed and tested strictly according to the international safety codes, however, certain safety precautions must be observed when installing and operating this inverter. Read and follow all the instructions, cautions and warnings in this user manual carefully before any work and keep this manual for future reference.

2.2 Notice for Use

2.2.1 Personnel requirements

Only qualified personnel are allowed to install and commission the inverter, they should:

- 1) Receive professional training and get the authorization.
- 2) Be familiar with the safety specification about the electrical system.
- 3) Be familiar with the local requirements, rules and regulations.
- 4) Understand the composition and working principles of the grid-tied PV system.

2.2.2 Operation requirements

Use the inverter in installations that meet the following specifications only.

- 1) Permanent installation is required.
- 2) The electrical installation must meet all the applications and standards.
- 3) The inverter must be installed according to the instructions stated in this manual.
- 4) The inverter must be installed according to the correct technical specifications.
- 5) To startup the inverter, the Grid Main Switch (AC) must be switched on, before the solar panel's DC solar switched on. To stop the inverter, the Grid Supply Main Switch (AC) must be switched off before the solar panel's DC isolator switched off.

2.2.3 Protecting labels

- 1) Do not scrawl or damage any labels on the inverter enclosure because these labels contain important information about safe operation.
- 2) Do not scrawl or damage the nameplate on the inverter enclosure. This nameplate contains important product information.

3 Product Overview

3.1 Product Introduction

The inverters are single-phase grid-connected PV string inverters without transformer, which can convert the DC power from the photovoltaic (PV) strings into alternating current (AC) power, and feed the power into the power grid.

This document involves the following product models:

CSI-3K-SS002-E; CSI-5K-SS002-E.

PV grid-connected system mainly includes PV modules, DC switch, inverter, AC switch, electricity meter, and local grid. The PV power system diagram is shown as FIG. 3-1.

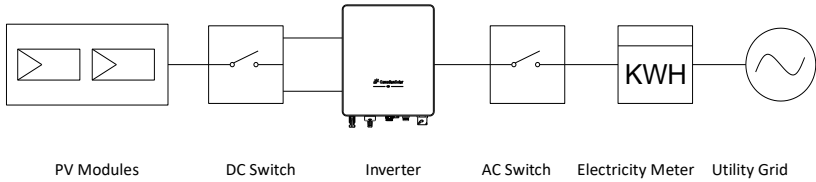
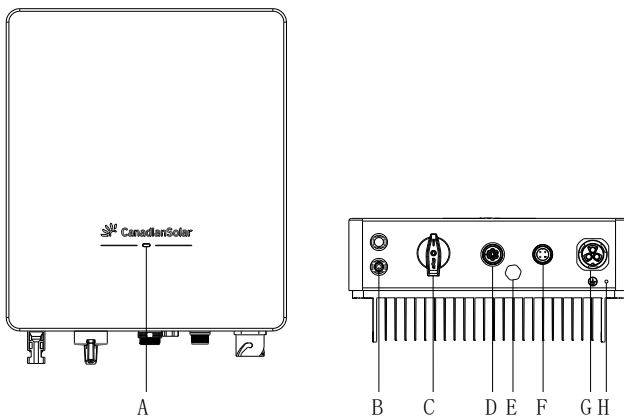

FIG. 3-1 PV Power System Diagram

3.2 Appearance

1) CSI-3K-S22002-E Front view and bottom view



2) CSI-5K-S22002-E Front view and bottom view

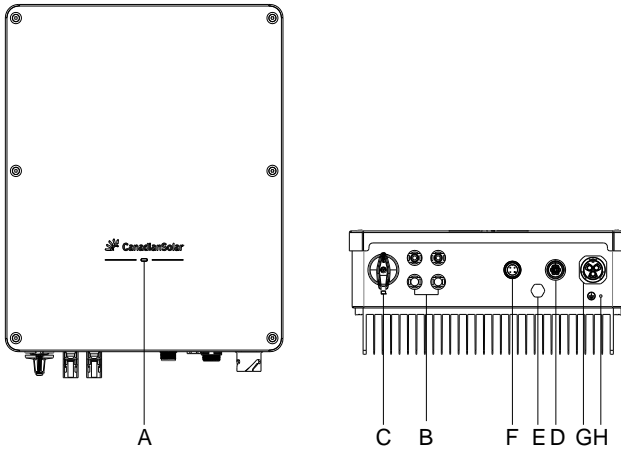



FIG. 3-2 Product Appearance

Object	Name	Description
A	LED indicator	Indicates inverter operation status.
B	DC input connectors	/
C	DC disconnect switch	Disconnect the DC current safely.
D	CT/Meter receptacle	Connect CT or Meter.
E	Waterproof and breathable valve	/
F	Communication port	Connect wireless datalogger (WiFi or GPRS), RS485.
G	AC receptacle	/
H	External ground point	/

3.3 Product Nameplate

The nameplate provides a unique identification of the inverter (Product type, Device -specific characteristics, Certificates and Approvals).

The nameplate is on the left side of the enclosure.

 **CanadianSolar**

Product name : Grid-connected PV Inverter

Model number: CSI-3K-S22002-E

Vmax. PV(absolute max.): 600V dc

MPPT voltage range: 60~500V dc

Max. input current: 12 A dc

Max. short-Circuit Current : 15 A dc

Rated output power: 3000W

AC nominal voltage : 220/240V ac

AC nominal frequency : 50 /60Hz





Max.output current: 13.6A ac



Power factor: >0.99(0.8 leading...0.8 lagging)

Overvoltage class: II(DC), III(AC)

Degree of Protection : IP65

Operating temperature range: -25°C...+60°C

 **CanadianSolar**

Product name : Grid-connected PV Inverter

Model number: CSI-5K-S22002-E

Vmax. PV(absolute max.): 600V dc

MPPT voltage range: 100~550V dc

Max. input current: 2 x 12 A dc

Max. short-Circuit Current : 2 x 15 A dc

Rated output power: 5000W

AC nominal voltage : 220/240V ac

AC nominal frequency : 50/60Hz

Max.output current: 25A ac





Power factor: >0.99(0.8 leading...0.8 lagging)

Protective class: Class I

Overvoltage class: II(DC), III(AC)

Degree of Protection : IP65

Operating temperature range: -25°C...+60°C







FIG.3-3 Inverter Nameplate (for reference)

4 Storage

The following requirements should be met when the inverters need to be stored:

Do not unpack the inverter.

Storage temperature: $-40^{\circ}\text{C} \sim +70^{\circ}\text{C}$.

Storage humidity: 0% ~ 100%RH (Non-Condensing).

The stored warehouse should be clean, well-ventilated, and non-corrosive gas, meanwhile it should be in a state of unimpeded access.

No smoking, no illegal use of electricity and fire.

When storing inverters, do not stack more than the allowed layers to avoid damage, which number marked on the product packaging.

Regular inspection is required during the storage.

After long periods storage, the inverters need to be inspected and tested by qualified persons before they are put into use.

5 Unpackaging and Inspection

Before unpacking the inverter, check the package appearance thoroughly, such as any holes and cracks, and check the inverter model accordingly. If discover any damage to the packaging which indicates the inverter may have been damaged, or the inverter model is not what you requested, do not unpack the product and contact your dealer immediately.

After opening the package, check all of the accessories carefully in the carton. If any damage is found or any component is missing, contact your dealer.

Note:

For details information about the components, see the packing list document in the packing case.

6 Installation

6.1 Basic Installation Requirements

- 1) Do not install the inverter on the structures constructed of flammable or thermolabile materials.
- 2) The installation surface must be strong enough to bear the inverter's weight for a long period time. (Please check the inverter's weight in the product specification of ANNEX B).
- 3) The inverter is protected to IP65, can be installed indoors and outdoors.
- 4) The humidity of the installation location should be below 100% without condensation.
- 5) The ambient temperature should be between -25°C to 60°C .
- 6) Install at eye-level for easy operation.
- 7) Do not install the inverter near television antenna or any other antennas and antenna cables.
- 8) Ensure the inverter is out of children's reach.
- 9) Install inverter at the locations with some cover or protection, to ensure the optimum operation.



FIG.6-1 Inverter Installation Positions

- 10) Do not install in small closed cabinet where air cannot circulate freely. Do not put any other objects on the inverter.

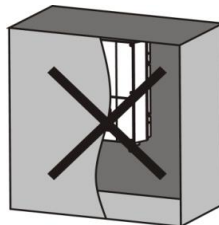
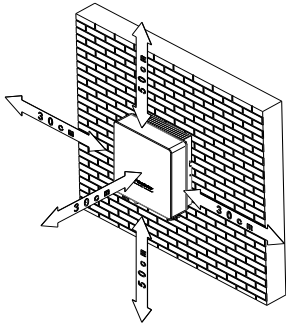

FIG.6-2 Forbid to Install in Small Closed Cabinet

- 11) Comply with the Min. clearance to walls, other inverters, or objects to ensure the installation and

maintenance, meanwhile for the good heat dissipation.



Direction	Min. clearance (cm)
Above	50
Below	50
Sides	30
Front	30

FIG.6-3 Installation Clearance Requirements

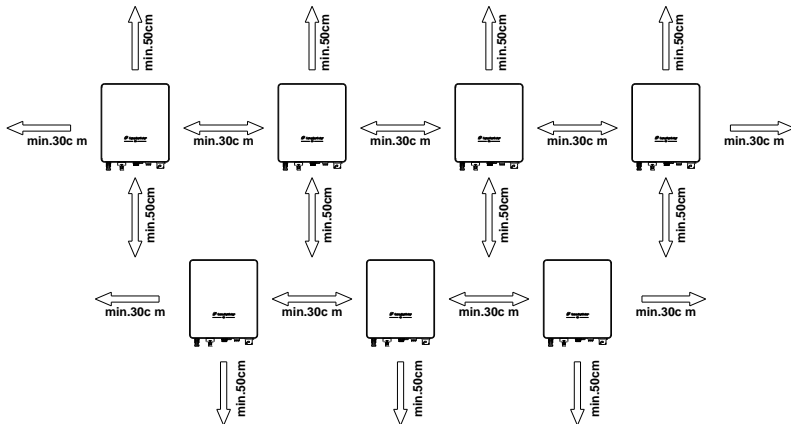

FIG.6-4 Staggered Installation Mode (Recommended)

12) Install the inverter vertically or at a maximum backward tilted angle of 15 degrees to facilitate heat dissipation.

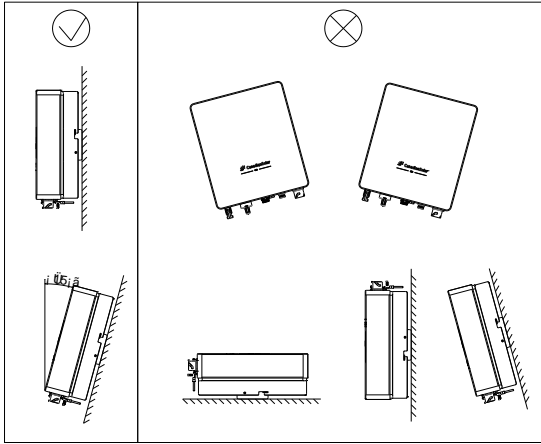



FIG. 6-5 Installation Angle Requirements

6.2 Mounting Wall-mounting Bracket

 Danger	<p>To avoid electrical shock or other injury, please inspect existing electronic or plumbing installations before drilling holes.</p>
--	---

Installation steps:

1) Use the wall-mounting bracket as a template and mark the positions of the drill holes, then drill the 4 holes accordingly, as per FIG. 6-6. (Diameter = 11mm, Depth ≥ 55mm) .

Note: The external dimensions (W × H) of inverters are shown as dash line in FIG. 6-6.

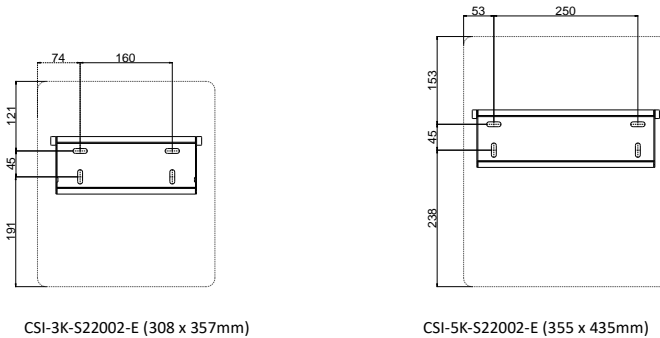

CSI-3K-S22002-E (308 x 357mm)

CSI-5K-S22002-E (355 x 435mm)

FIG. 6-6 Drilling Positions

2) Knock expansion anchors into the corresponding four holes, and then fix the wall-mounting bracket to the wall with self-tapping screws, as per FIG. 6-7 & FIG. 6-8.

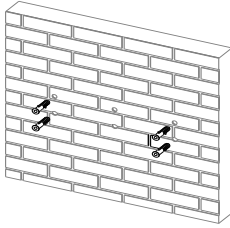

FIG.6-7 Install Expansion Anchors

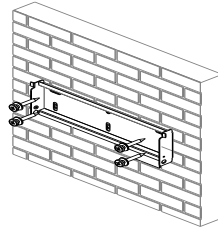

FIG.6-8 Fix Wall-mounting Bracket

6.3 Installing Inverter

Note: Must make sure the wall-mounting bracket has mounted on the wall firmly before install inverter.

Installation steps:

- 1) Hang the inverter on wall-mounting bracket. Keep balance during the operation to prevent device damage from colliding with walls or obstacles, as per FIG. 6-9.

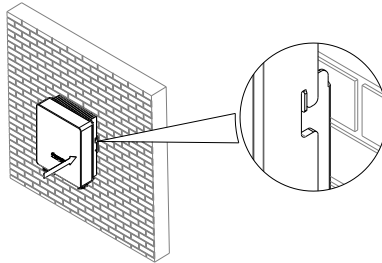

FIG. 6-9 Hang the Inverter on Wall-mounting Bracket

- 2) Use two safety bolts to fix both sides of inverter to ensure the inverter fixed to the wall firmly, as per FIG. 6-10.

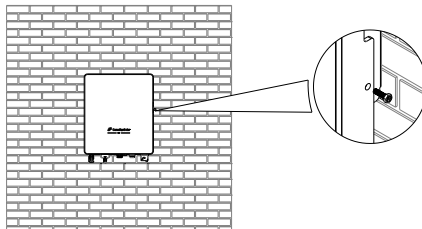



FIG. 6-10 Fix Both Sides of Inverter

7 Electrical Connection

7.1 Safety

 Danger	<p>Danger to life due to lethal voltages in the inverter!</p> <p>Before performing any work on the inverter, must disconnect both AC and DC sides.</p>
 Warning	<p>Damage to electronic components may happen due to electrostatic discharge. Take appropriate ESD precautions when replacing and installing the inverter.</p>

7.2 Network Diagram

Electrical connections of inverter include grounding connection, PV array connection, AC connection and communication connection.

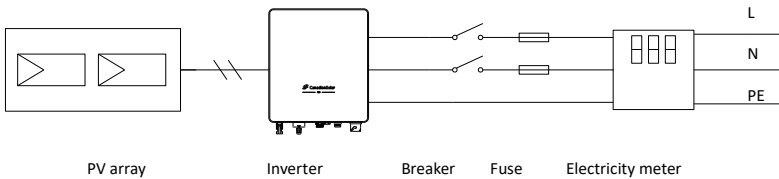

FIG. 7-1 Network Diagram

7.3 Meter/CT Connection (Optional)

The inverter has integrated export limitation functionality. To use this function, a power meter or a CT must be installed.

7.3.1 Meter connection

If use the meter, it shall be installed in the load side, shown as FIG. 7-2.

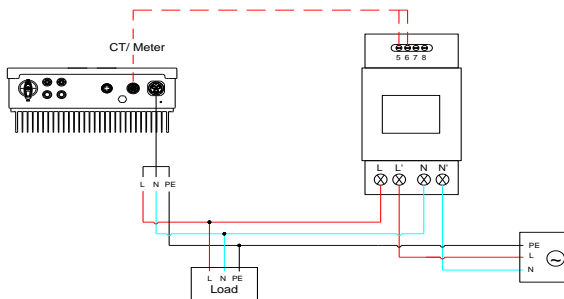

FIG. 7-2 Meter Connection in Load

7.3.2 CT connection

If use the CT, it shall be fitted around the live conductor on the grid side of the main incoming consumer unit, shown as FIG. 7-3. Use the direction flow indication arrow on the CT to ensure it is fitted in the correct orientation.

Note: The arrow shall be pointing towards the grid, not the load.

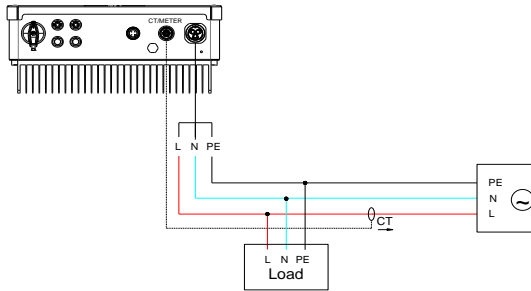

FIG. 7-3 CT Direction

7.4 Cable Description

Cable Name	Cable Type	Conductor Cross-Sectional Area	Outer Diameter
DC input cable	PV cable, above 600V.	4~6mm ²	5.5~7.4mm
AC output cable	Three cores outdoor cable with copper conductor.	4~6mm ²	10~14mm
Signal cable	Two cores cable.	0.2-0.75mm ² (24~18AWG)	3.5~5.5mm
PE cable	Single core outdoor cable with copper conductor.	4~6mm ²	N/A

Note: No cable is supplied.

7.5 Wiring PE Cable

To achieve ground protection purpose, the inverter must be connected to the AC grounding conductor of the utility grid via PE cable.

 Warning	<p>Because of the transformerless design, the DC positive pole and DC negative pole of PV arrays cannot do grounding.</p>
---	---

Note: The PE point at the AC output point is used only as a PE equipotential point, and cannot substitute for the PE point on the enclosure.

Procedure steps:

- 1) Insert the grounding conductor into the suitable terminal lug and crimp the contact.
- 2) Fix terminal lug on external ground point by screw M4x10. Torque: 1.4 N.m.

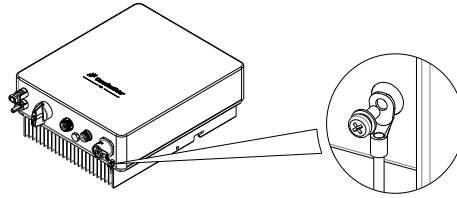



FIG. 7-4 External Grounding Point Position

7.6 Wiring AC Output

 Warning	<p>To ensure the inverter can be safely disconnected with load, must install a separate single-phase circuit-breaker or other load disconnection unit for each inverter.</p> <p>Note: The inverter is equipped with integrated RCM (Residual current operated monitor) and RCD (Residual current protective device). The rated residual current of the circuit breaker must be over 300mA when the AC circuit breaker with RCM function selected.</p>
 Notice	<p>When using inverter comply with VDE-AR-N 4105: The total capacity of PV-inverter system cannot exceed 13.8KVA, and the adjustment function of inverter's displacement power factor must comply with VDE-AR-N 4105.</p> <p>When using inverter comply with CEI 0-21: The total capacity of PV-inverter is more than 3KW and less than or equal 6KW, the inverter's displacement power factor is adjustable between 0.95 leading to 0.95 lagging, and do not need external SPI.</p> <p>The total capacity of PV-inverter is more than 6KW, the inverter's displacement power factor is adjustable between 0.9 leading to 0.9 lagging, meanwhile need external SPI.</p>

Install an independent two-pole circuit breaker at the output side of the inverter for protection, the recommended AC circuit-breaker specifications are as follows:

Inverter type	AC circuit-breaker specifications
CSI-3K-S22002-E	25A
CSI-5K-S22002-E	32A

Recommend AC cable length:

Inverter type	Conductor cross section 4.0mm ² (Allowed Max. length)	Conductor cross section 6.0mm ² (Allowed Max. length)
CSI-3K-S22002-E	53 (m)	79 (m)
CSI-5K-S22002-E	29 (m)	43 (m)

AC wiring procedure steps:

The grid connection is established by using three-core wire (L, N, and PE, as per FIG. 7-5).

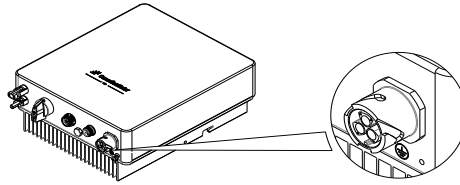

FIG. 7-5 AC Connector

The AC connector is made of four components: pressure screw, sealing ring, threaded sleeve, and socket element.

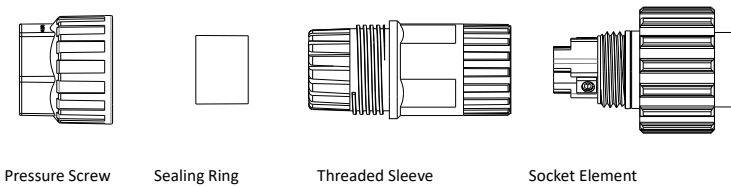

FIG. 7-6 Structure of AC Connector

AC connectors have two types, EXCEEDCONN type or DEVALAN type, procedure steps as below:

1) Strip the cable's jacket, and then adjust the relative length of L, N and PE cables, to make the length of PE cable is at least 5mm longer than L and N ones, as per FIG. 7-7.

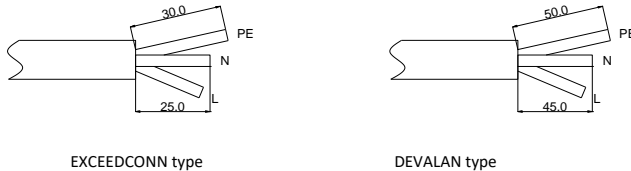

FIG. 7-7 Adjust the Cable Length

2) When using flexible cables, the conductor must be connected with suitable core end ferrules according to DIN 46228-4, as per FIG. 7-8.



FIG. 7-8 Crimp the Three-core's Ferrule

Insert the L, N, and PE conductors into the corresponding terminals of the sockets element (as per FIG. 7-9), then tighten the screws firmly by screwdriver.

EXCEEDCONN type (Torque 0.8N.m) :

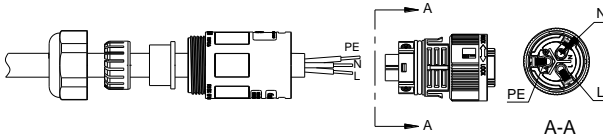

DEVALAN type (Torque 1.4N.m) :

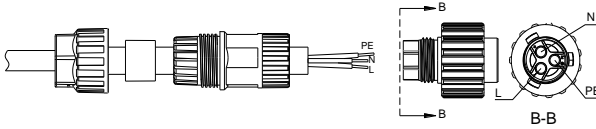
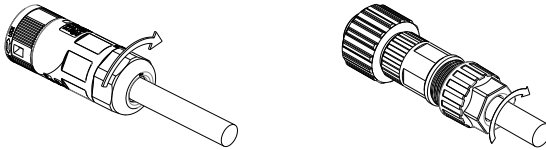

FIG. 7-9 AC Terminal Positions

3) Push the threaded sleeve into the socket element, screw the press screw tightly.



EXCEEDCONN type

DEVALAN type

FIG. 7-10 Tightening the AC Connector

4) Finally, insert the AC connector into the corresponding AC receptacle on the inverter. Pay attention to the polarities to make sure the correct assembling.

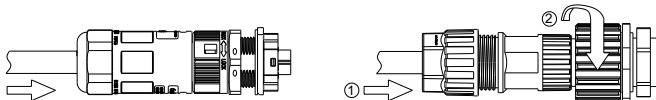

EXCEEDCONN type

DEVALAN type

FIG. 7-11 Installing the AC Connector

7.7 Wiring DC Input

Note: The DC connectors are in paired (negative and positive ones). Pay attention to the polarities

when assembling.

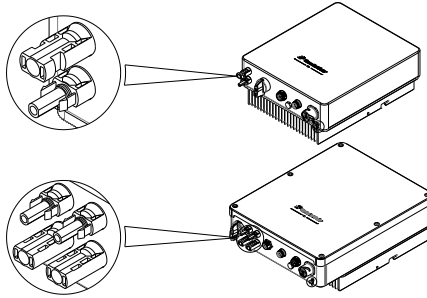

FIG. 7-12 DC Input Connectors

7.71 Requirement for DC input

This single-phase inverter is equipped with one / two MPP trackers.

Requirements for PV modules strings:

- 1) Same type.
- 2) The power, voltage (startup and open-circuit voltage) and operating current of each PV strings must meet the allowable value of the inverter.

Note: Consider temperature coefficient of the PV modules.

Check the inverter specification in section ANNEX B.

7.72 Wiring

There are two types of DC connectors—MC4/H4, check the connector's type for completeness before assembling.



Negative Coupler & Contact Pin Positive Coupler & Contact Pin.

FIG. 7-13 Structure Illustration of DC Connector

Procedure steps

- 1) Strip the insulation of cable to about 7.5mm with the wire stripper tool. Note do not damage the conductors when do the stripping, as per FIG. 7-14.
- 2) Place the contact around the conductors of the stripped cable, then crimp the contact with wire crimping pliers, as per FIG. 7-15.

Ensure the conductors completely wrapped without loosening or damage.

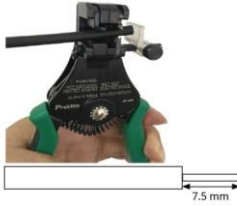

FIG. 7-14 Strip the Cable Insulating Layer

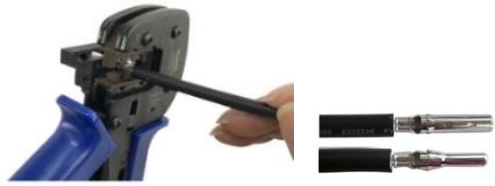

FIG. 7-15 Crimp the Contact

3) Insert the crimped contact pin into the connector back until one click audibly. Pull lightly on the cable to ensure the contact pins of the connectors are engaged. Pay attention to the polarities when assembling.

4) Tighten the nut with a special wrench. Torque: 2.5~2.9 N.m.



FIG. 7-16 Insert the Contact



FIG. 7-17 Tighten the Cable Gland

5) Insert the assembled connectors into the bottom terminal of the inverter until one sound click audibly.

The locked DC connectors can only be disconnected with special tool.

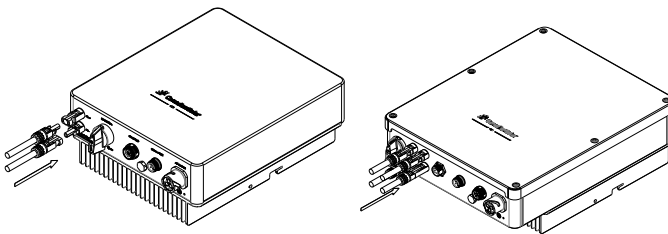

FIG. 7-18 Illustration of DC Ports

7.73 Connecting PV array (DC input)



Danger

Ensure the DC switch and AC breaker both are disconnected from the inverter before connect the PV arrays.

Never connect PV array positive or negative pole to the ground, it could cause serious damages to the inverter.



Warning

Improper operation during the wiring process can cause fatal injury to the operator or unrecoverable damage to the inverter.

Only qualified personnel can perform the wiring work.

7.8 Wiring CT/Meter

Diagram of CT or Meter connector:

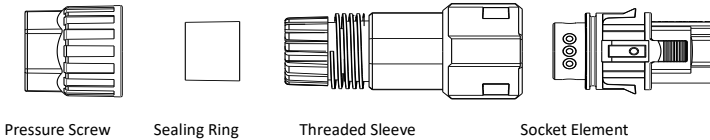

FIG. 7-19 Structure Illustration of CT or Meter Connector

Procedure steps (DEVALAN and EXCEEDCONN types):

- 1) Remove the signal cable's jacket by about 23mm, and then strip the wire insulation layer by about 7mm.

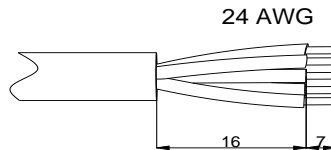
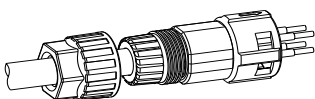

FIG. 7-20 Prepare the Signal Cable

- 2) Insert the conductors into the corresponding terminals of the sockets element, and then lock the conductors by screws firmly. Torque: 0.6~0.8N.m.

Connector Pin DEVALAN type	Function	CT/Meter Pin
1	485A	METER Pin-5
2	485B	METER Pin-6
3	485_GND	/
5	/	CT+
6	/	CT-

Connector Pin EXCEEDCONN type	Function	CT/Meter Pin
1	485A	METER Pin-5
2	485B	METER Pin-6
3	485_GND	/
PE	/	CT+
N	/	CT-



DEVALAN type

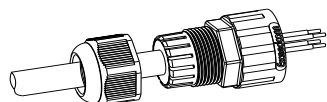

EXCEEDCONN type

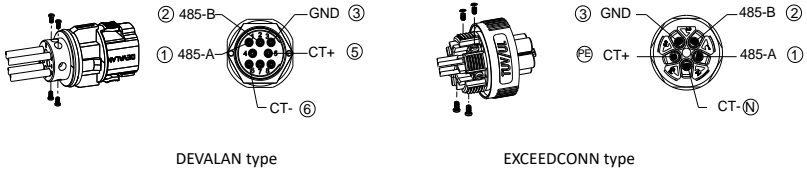

FIG. 7-21 Connector Positions

3) Screw the press screw tightly, and then push the threaded sleeve into the socket.

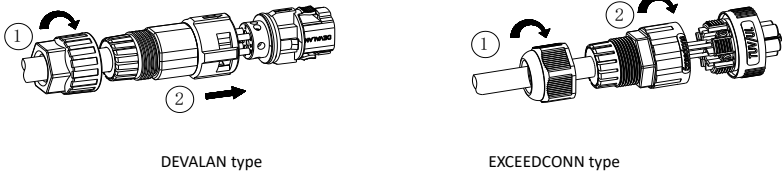

FIG. 7-22 Assembling the Connector

4) Finally insert the assembled connector into the CT/Meter receptacle on the inverter.

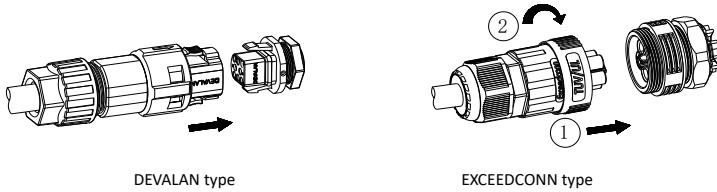

FIG. 7-23 Tightening the Connector

8 Communication

8.1 Communication Mode

Multi communication patterns for option, RS485 (Built-in module), GPRS, and WIFI, with the communication port M16.

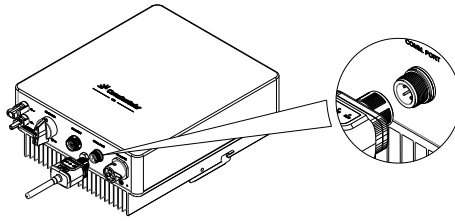

FIG. 8-1 Communication Port

8.2 RS485

Connect the communication port with a RS485-to-usb port converter via RS485 serial line, and then connect this module to PC.

8.3 External GPRS (Optional)

The external GPRS communication module is used for remote monitoring. More details for installation and operation method please refer to the GPRS user manual (Note, no SIM card provided from Canadian Solar).

8.4 External WiFi

The external WiFi communication module is used for wireless remote monitoring. More details for installation and operation method please refer to the WiFi user manual.

9 Commissioning Inverter

9.1 Checking Electrical

1) Check PE connections with multi-meter:

To make sure all the bare metal surfaces of the inverter are grounded.

2) Check DC voltage value:

Check if the DC voltage of the PV string exceeds the allowable range.

3) Check the polarities of the DC voltage:

To make sure the DC polarities are correct.

4) Check the ground insulation of PV array with multi-meter:

Ensure the impedance value of ground insulation is more than 1MΩ.

9.2 Checking Mechanical

1) Ensure the inverter is installed properly, fixed with a Wall-mounting bracket firmly, and the upper cover is installed correctly.

2) Ensure the AC connectors are installed properly and fixed firmly.

3) Ensure the dust covers are sealed reliably which are used for the empty DC connectors.

4) Ensure all the cables are connected effectively, fixed firmly, and no visible damages to the insulation layers.

9.3 Start-UP Inverter

After electrical and mechanical inspections, first turn on the AC main switch/breaker, then turn on the DC switch. The inverter will start automatically when the DC input voltage meets the performance requirement of the utility grid.

Normally there will be three statuses during the operation (refer to the LED indications):

1) Waiting:

Conditions: The initial DC voltage of the PV strings is greater than the Min. DC input voltage, but is lower than the DC start-up input voltage.

Inverter cannot start-up normally and cannot feed power into utility grid either.

2) Checking:

Conditions: The initial voltage of the PV strings exceeds the start-up DC input voltage of the inverter.

Meanwhile both the voltage and frequency of the utility grid are normal.

Inverter will check the feeding conditions immediately. If anything wrong during checking, inverter will switch to the "Fault" mode.

3) Normal:

Conditions: All the checking results are normal.

Inverter will switch to "Normal" mode and feed power into utility grid.

The inverter may turn on and off continuously during the period of low or absent sunlight due to the shortage of power generated by the PV modules. If such fault occurs frequently, please contact the maintenance personnel.

Note: For the monitoring and local APP information, please refer to documents published on our website at: <https://monitoring.csisolar.com/platformSelect>.

9.4 LED Indicators

No.	Operate states	LED Indicators	Flicker frequency
1	Wait	Green LED flicker	1s On, 1s Off
2	Normal	Green LED always on	/
3	Error	Red LED always on	/

9.5 Switch off





 DANGER	<p>Never connect or disconnect the DC connectors under load.</p>
--	--

Inverter Turn-off steps:

- 1) Turn off the AC main switch to prevent it from being reactivated.
- 2) Turn off the DC switch.
- 3) Check the inverter operating status.
- 4) Wait until LED indicator has gone out, which indicates the inverter has been shut down.

10 Daily Maintenance

 DANGER	<p>Risk of inverter damage or personal injury due to incorrect service! Always keep in mind that the inverter is powered by dual sources: PV array and utility grid.</p> <p>Before any service work, observe the following procedure.</p> <ol style="list-style-type: none"> 1) Disconnect the inverter from the utility grid side first and then PV array; 2) Wait at least 5 minutes after shun down the inverter, for inner capacitors to discharge completely; 3) Verify that no voltage and current existing with appropriate testing devices.
--	---

 CAUTION	<p>Keep non-related persons away!</p> <p>A temporary warning sign or barrier must be posted to keep non-related persons away while performing electrical connection and service work.</p>
 NOTICE	<p>Risk of inverter damage if it is improperly serviced.</p> <p>Use accessories and spare parts approved by the inverter manufacturer only.</p> <p>Never modify the inverter or other components of the inverter. The loss of any or all warranty rights may follow if otherwise.</p>
 NOTICE	<p>Any malfunction that may impair the inverter safety operation must be repaired immediately before the inverter is restarted.</p> <p>Inverter contains no customer serviceable parts inside. Please contact local authorized personnel if any service work is required.</p>
 Information	<p>Servicing of the device in accordance with the manual should never be undertaken in the absence of proper tools, test equipments or the more recent revision of the manual with has been clearly and thoroughly understood.</p>

Items	Methods	Period
System clean	<p>Check the temperature and dust of the inverter. Clean the inverter enclosure.</p> <p>Check the humidity and dust of the environment.</p> <p>Meanwhile check whether the filter function of the air inlet is ok.</p>	Six months to a year (it depends on the dust contents in air.)

11 Trouble Shooting

When inverter does not operate normally, we recommend the following actions for quick troubleshooting. Please review the error list table carefully.

11.1 Warning

The different LED colors and flashing status identify the current operation statuses of the inverter. If the red color is always on, it indicates the inverter fault. Usually the warnings can be cleared through an orderly shutdown / reset or a self-corrective action performed by the inverter.

11.2 Errors

Error codes identify a possible equipment fault, or incorrect setting/ configuration. Any and all attempts to correct or clear a fault must be performed by qualified personnel. Typically, the Errors code can be cleared once the cause or fault is removed.

However, some of the (E) codes may not be cleared, in this case please contact the dealer or Canadian Solar to replace a new one.

Errors as indicated in the table below:

Error Code	Error Message	Suggestion
F-100	Over temperature	<ol style="list-style-type: none"> 1. Check heatsink for obstructions/ventilation. 2. Check the ambient temperature around the inverter.
F-101	High DC input voltage	<ol style="list-style-type: none"> 1. Disconnect the DC switch, remove the DC connector, measure the voltage of the PV string, and check if it exceeds the input-voltage specification of the inverter. 2. If exceed the specification, re-layout the PV module string. 3. If not exceed the specification, while the error still exists, please contact Customer Service.
F-103	Unconnected grid	<ol style="list-style-type: none"> 1. Turn off DC switch, remove AC connector, measure the voltage between fire line and the zero line, then check if it is consistent with the grid-connected specification of inverter. 2. Inconsistent, check if the AC main switch is connected, check if the power supply is normal working. 3. Consistent, connect the AC connector, turn on the DC Switch. 4. If error message still exists, contact Customer service.
F-104	Inverter grid-connected relay fault	Contact Customer service.
F-105	Grid frequency fault	<ol style="list-style-type: none"> 1. If power grid frequency returns to normal, the inverter will restore the grid connection automatically. 2. If error message still exists, contact Customer service.
F-106	Grid voltage fault	<ol style="list-style-type: none"> 1. Turn off DC switch, remove AC connector, measure the voltage between fire line and the zero line, then check if it is consistent with the grid-connected specification of inverter. 2. Inconsistent, check the grid layout. 3. Consistent, connect the AC connector, turn on DC Switch, inverter will restore the grid connection automatically. 4. If error message still exists, contact Customer service.
F-107	DC component over range	<ol style="list-style-type: none"> 1. Restart inverter. 2. If error message still exists, contact Customer service.
F-108	Current sensor fault	<ol style="list-style-type: none"> 1. Wait until inverter restores normal work. 2. If error message still exists, contact Customer service.
F-110	Leakage current detection unit fault	<ol style="list-style-type: none"> 1. Check if there is any PV cable breakage. 2. Check if the PV modules grounding improperly. 3. Restart inverter. 4. If error message still exists, contact Customer service.
F-111	Leakage current fault	<ol style="list-style-type: none"> 1. Check if PV strings grounding properly.

		2. If error message still exists, contact Customer service.
F-112	DC insulation fault	<ol style="list-style-type: none"> 1. Check if inverter grounding properly. 2. Check if the positive and negative poles of PV modules are short out to the PE cable. 3. Wait until inverter restores normal work. 4. If error message still exists, contact Customer service.
F-113	Leakage current detection consistency error (Major)	<ol style="list-style-type: none"> 1. Restart the inverter. 2. If error message still exists, contact Customer service.
F-114	Frequency detection consistency error (Major)	<ol style="list-style-type: none"> 1. Restart the inverter. 2. If error message still exists, contact Customer service.
F-115	Power grid voltage detection consistency error (Major)	
F-116	Leakage current detection consistency error (Minor)	
F-117	Frequency detection consistency error (Minor)	
F-118	Power grid voltage detection consistency error (Minor)	
F-123	Secondary memory failure	<ol style="list-style-type: none"> 1. Restart the inverter. 2. If error message still exists, contact Customer service.
F-124	Clock failure	
F-125	Internal communication failure	
F-129	Main memory failure	

12 Handling the Inverter

12.1 Removing Inverter

- 1) Turn off the inverter as described in section 10 and section 11.
- 2) Remove all the connection cables from the inverter.
- 3) Unscrew the fixing screws on both sides of the inverter.
- 4) Remove the inverter from the bracket.

Note: Before performing any work, ensure that you are familiar with this document.

12.2 Packing Inverter

If possible, use the original packaging, or the packaging that is suitable for the weight and dimensions of the inverter.

12.3 Disposing Inverter



Do not dispose the obsolete inverters or accessories together with household waste. Please refer to the disposal regulations.

ANNEX A: Acronyms and Abbreviations

AC	alternating current
CT	current transformer
DC	direct current
GPRS	general packet radio service
LED	light emitting diode
MPPT	maximum power point tracking
PC	personal computer
PE	protecting earthing
PV	photovoltaic
RCD	residual current protective device
RCM	residual current operated monitor
THDi	total distortion of the input current waveform
WiFi	wireless fidelity
WEEE	waste electrical and electrical equipment

ANNEX B: Specification

Model	CSI-3K-S22002-E	CSI-5K-S22002-E
Input (DC)		
Max. DC Input Power (W)	4080	6500
Max. DC Input Voltage (V)	600	600
Startup DC Input Voltage (V)	60	110
MPPT Operating Voltage Range (V)	60~500	100~550
Rated Input Voltage (V)	360	360
Max. Input Current (A)	12	12/12
Max. Short-Circuit Current (A)	15	15/15
Number of MPP Trackers	1	2
Number of DC Inputs	1/1	1/1
Output (AC)		
Rated Output Power (W)	3000	5000
AC Grid Connection Type	L/N/PE	
AC Nominal Voltage And Range (V)	220/230/240 (180~280)	
AC Nominal Frequency And Range (Hz)	50/60 (±5)	
Max. Output Current (A)	13.6	25
Power Factor(@ Rated Output Power)	>0.99	
Displacement Power Factor	0.8 leading to 0.8 lagging	
Total Harmonic Distortion (THDI)	<3%	
Efficiency		
Max. Efficiency	97.8%	98.0%
European Efficiency	97.1%	97.5%
MPPT Efficiency	99.9%	99.9%
Safety & Protection		
DC Switch	Integrated	
Anti-Islanding Protection	Integrated	
DC Reverse-Protection	Integrated	
Insulation Monitoring	Integrated	
AC Over Voltage Protection	Integrated	
AC Over Current Protection	Integrated	
AC Short-Circuit Protection	Integrated	
Residual Current Protection	Integrated	
Overvoltage Class	II (DC), III (AC)	
General Parameters		
Dimensions (W × H × D, mm)	308 x 357 x 126	355 x 435 x 158
Net Weight (kg)	8.2	13.5

Installation Method	Wall - mounted
DC Connection Type	H4 / MC4
AC Connection Type	Connector
Communication Interfaces	M16 (WiFi / RS485 / GPRS Optional)
Cooling	Natural convection
Protection Degree	IP65
Operating Ambient Temperature Range (°C)	-25~60 (>45, derating operation)
Relative Humidity (Non-Condensing)	0% ~ 100%
Max. Operating Altitude (m)	4000 (>3000, derating operation)
Acoustic Noise Emission Level(dBA)	< 25
Topology	Transformerless
Night Power Consumption (W)	<1
Safety and EMC	IEC 62109-1/2, IEC 61000-6-1, IEC 61000-6-3
Grid Connection Standard	ABNT NBR 16149 / 16150:2013, IEC 61727, IEC 62116

Canada – Global Headquarters

Canadian Solar Inc.

545 Speedvale Avenue West, Guelph, Ontario, N1K 1E6

P +1 519 837 1881

F +1 519 837 2550

Sales Inquiries Email: info@canadiansolar.com

Customer Support Email: service.ca@canadiansolar.com