

# Smart Data Logger (WIFI&LAN) Quick Installation Guide

**Model:** CSCU-ST-WL01/ CSCU-ST-WLP01  
**Part No:** 91000273; **Release Date:** 2023/09

## Statement

Please read this guide carefully before using the product, and keep it in a place where maintenance personnel can easily find it.

Due to product version upgrades or other reasons, the content of this document may be updated from time to time. Users should refer to the actual product purchased and can download the latest version of the manual materials through the official website or sales channels. Unless otherwise agreed, this document is intended as a guide only. All statements, information, and recommendations in this document do not constitute a warranty of any kind, express or implied. Without the written permission of the company, no entity or individual may extract, copy, or disseminate the contents of this document in any form.



**NOTE: Precautions for installing the data logger insert and remove the data logger after power is off.**

## Install The Network Cable

- Step 1: Remove the "Plastic Nut", "Thread Clamp Claw", and "Sealing Ring" in turn;
- Step 2: Pass the network cable plug through the "Plastic Nut", "Thread Clamp Claw", and "Sealing Ring" (with opening) in the direction as shown in the figure below.

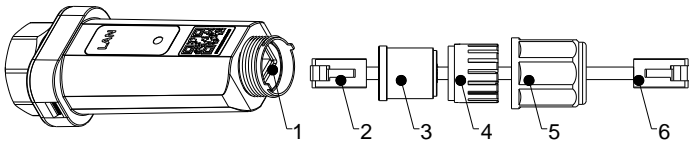

Name of each part

1	2	3	4	5	6
Ethernet Port	RJ45 Plug to Stick	Sealing Ring	Thread Clamp Claw	Plastic Nut	RJ45 Plug to the router

- Step 3: Fully embed the "Sealing Ring" into the "Thread Clamp Claw".
- Step 4: Connect the "RJ45 Plug" to the datalogger and tighten the "Plastic Nut".



**Due to space constraints, the RJ45 plug cannot use a protective cap. To ensure good sealing, the diameter of the network cable should be 4 ~ 7mm.**

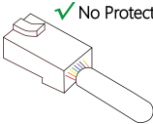

✓ No Protection

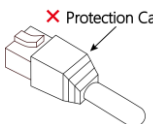

✗ Protection Cap

## Install Data Logger

### 1. Installation Steps

- Step 1: Find the communication interface on the inverter and unscrew the protective cap;
- Step 2: Insert the data logger along the interface guide slot;
- Step 3: Tighten the fastening nut clockwise.

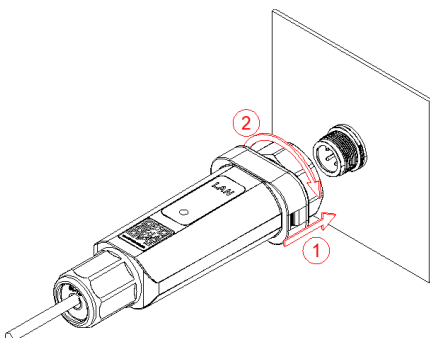

### 2. WIFI Network Configuration

If you want to connect the Data Logger to the WIFI network, you need to disconnect the network cable from the router. Then connect the data logger to the WIFI network according to the steps of "Data Logger WIFI Network Configuration" in the APP User Guide. After the LAN or WIFI network connection is successful, the subsequent function confirmation can be performed.

### 3. Confirmation of Data Logger Status

- Confirm the status of the data logger through the indicator light

Color	Status	Note	Description
-	Off	powered off	data logger is not tightened or powered on
Yellow	Steady on for 5s	power-on initialization	data logger is in a power on initialization state
Green	Blinking (1s on, 1s off)	normal operation	communication with server and inverter is normal
Yellow	Blinking (1s on, 1s off)	error state	communication with the server is abnormal
Red	Blinking (1s on, 1s off)	error state	communication with the inverter is abnormal
	Steady on	error state	communication with the inverter and server is abnormal

### 4. Abnormal Status Handling

If there is any abnormal platform data, please refer to the table below and complete simple troubleshooting based on the status of the LED lights. If the fault cannot be resolved or the indicator light fault status is not reflected in the table below, please contact after-sales service for assistance. (NOTE: Use the following table one minute after the WIFI network is configured successfully)

Color	Status	Note	Quick Troubleshooting
Yellow	Blinking (1s on, 1s off)	error state	Check the WIFI connection status. If it cannot be solved, please contact the distributor.
Red	Blinking (1s on, 1s off)	error state	Check if the connection between the data logger and the photovoltaic equipment is normal.
	Steady on	error state	1. Check if the connection between the data logger and the photovoltaic equipment is normal; 2. Check the WIFI connection status. If it cannot be solved, please contact the distributor.

### 5. Data Logger One-to-many Installation (only CSCU-ST-WLP01 is supported)

If you need to collect data on multiple inverters, connect them in daisy chain mode using an RS485 communication cable by referring to the Communication Connection section in the inverter user manual.

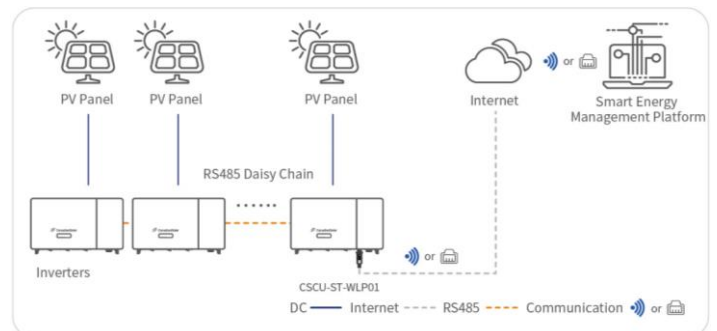



**Please ensure that the data logger is working properly before leaving the site. If any abnormal conditions are found, please contact your distributor as soon as possible.**

# APP User Guide

## APP Download

Please scan the following QR code to download.



You can also log in <https://smartenergy.csisolar.com> to use web version.

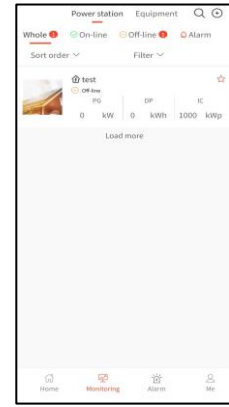

## APP Guide

**NOTE: The screenshot of the APP is for reference only. Please refer to the actual interface.**

### 1. Register & Log in

After entering the APP, please click the "Register" button to register the account.

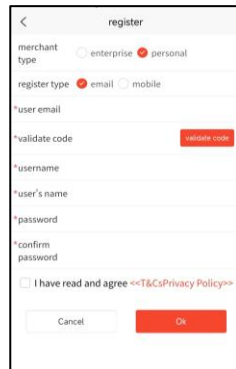
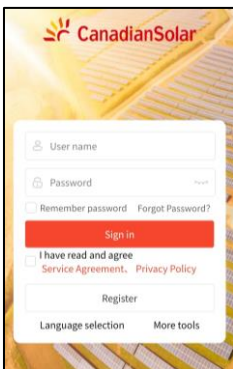

If you are a power station owner or end user, set the user type to **personal**.  
If you are engaged in the photovoltaic industry dealers, equipment, operation and maintenance business, please select the user type as **enterprise**.

### 2. Data Logger WIFI Network Configuration

Connect the mobile phone to the target WIFI network in advance. On the login page, click on "More Tools" and select the "WIFI Configuration" option. Follow the prompts to scan the data logger QR code to enter the WIFI configuration page. Enter the account password of the WIFI router for network configuration. (Bluetooth needs to be turned on for distribution phones)

**NOTE: Only supports 2.4GHz WIFI networks, 5GHz is not supported.**

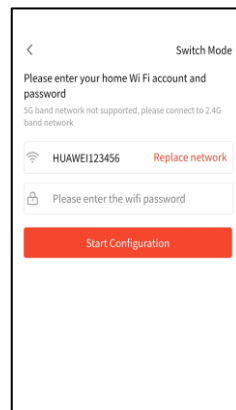
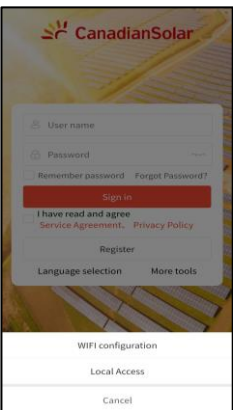

### 3. Create the Power Station

As shown in the following figure, click on "Monitoring" below to enter the monitoring page. Click on "+" in the upper right corner and fill in the information according to the prompts to start creating your photovoltaic power station. After creation, the monitoring page will display your power station information.

### 4. Add Data Logger

After entering the power station, click on the "..." icon in the upper right corner, and a function page will pop up below. Select the associated device and go to the associated device page. You can manually enter the serial number of the data logger or scan the QR code of the serial number on the data logger to add it. The serial number is usually located on the packaging box of the device. If the packaging box has been lost, you can also find the code on the data logger body.

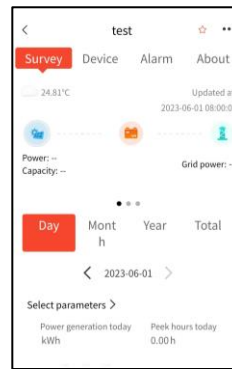

### 5. Check Information

After adding a data logger, you can view the data in your power station, and click on the power station to view the details. If it is difficult to find the power station you need due to the large number of power stations, you can search in the upper right corner of the monitoring column based on the name.

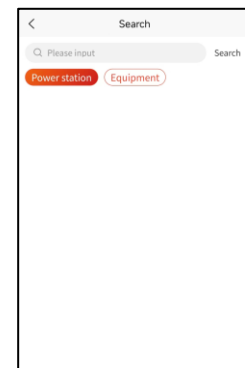
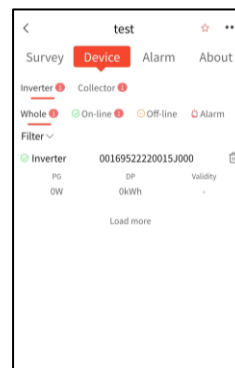

If you have any questions about the use or quality of our products, please contact us and provide the following information:

- data logger model and serial number
- connected inverter model and serial number
- problem description

## Contact Us

CSI Solar Co., Ltd.  
199 Lushan Road, SND, Suzhou, Jiangsu, China, 215129  
Sales Inquiries Email: [support@csisolar.com](mailto:support@csisolar.com)