

FICHA TÉCNICA

KIT FIBROCIMENTO MADEIRA 250MM

KIT PARA 2 MÓDULOS



Características do produto:



- Material: Alumínio 6060-T5 e aço inox 304;
- Rosca Métrica M10;
- Rosca Soberba Ø8mm;
- Dimensão: 250mm;
- Quantidade: 4 unidades.

Itens Inclusos:

- 4x suporte reto em alumínio;
- 16x porca sextavada/flangeada;
- 4x borracha de silicone para vedação.

Acessórios para instalação:



Grampo Intermediário

- Material: Alumínio 6060-T5
- Quantidade: 2 unidades.
- Atende módulos de 30mm, 33mm, 35mm e 40mm;



Grampo Terminal

- Material: Alumínio 6060-T5
- Quantidade: 4 unidades.
- Atende módulos de 30mm, 33mm, 35mm e 40mm;

Perfil Compatível:



Perfil Smart

- Material: Alumínio 6060-T5;
- Comprimento: 2,40m;
- Peso: 0,454 kg/m;



Perfil Smart X

- Material: Alumínio 6060-T5;
- Comprimento: 2,40m;
- Peso: 0,405 kg/m;

Equipamentos necessários:



Furadeira /
Parafusadeira



Trena



Nível



Chave fixa 10mm
Bit (soquete) 8mm

FICHA TÉCNICA

KIT FIBROCIMENTO MADEIRA 250MM

KIT PARA 2 MÓDULOS



Paletização de acessórios:

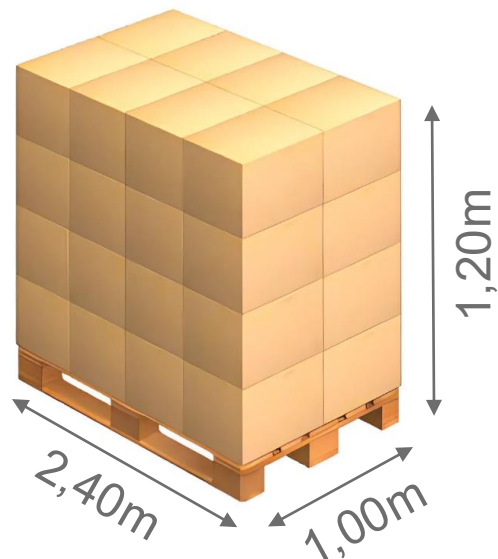

Kit de Acessórios

- Código: ASMFB240X000MD02;
- Quantidade: 200 unidades;
- Peso: 253,46 Kg.

Paletização de perfil:

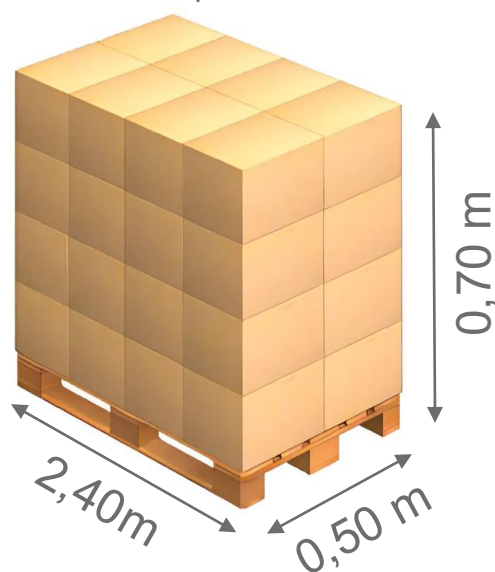

Kit de Acessórios

- Código: KSMFB240X000MD02;
- Quantidade: 100 unidades;
- Peso: 202,60 Kg.

Equipamentos necessários:



Furadeira /
Parafusadeira



Trena



Nível



Chave fixa 10mm
Bit (soquete) 8mm